



T-BAT-SYS-HV-S25

T-BAT-SYS-HV-S36

Installation Manual



eManual in the QR code or at
<http://kb.solaxpower.com/>

www.solaxpower.com















2022-12_Rev_00_EN

Safety

General Notice

1. Contents may be periodically updated or revised. SolaX reserves the right to make improvements or changes in the product(s) and the program(s) described in this manual without the prior notice.
2. The installation and maintenance can only be performed by qualified personnel who:
 - Are licensed and/or satisfy state and local jurisdiction regulations;
 - Have good knowledge of this manual and other related documents.
3. Before installing the device, carefully read, fully understand and strictly follow the detailed instruction of the user manual and other related regulations. SolaX shall not be liable for any consequences caused by the violation of the storage, transportation, installation, and operation regulations specified in this document and the user manual.
4. Use insulated tools when installing the device. Individual protective tools must be worn during installation, electrical connection and maintenance.
5. Please visit the website www.solaxpower.com of SolaX for more information.

Descriptions of Labels

	CE mark of conformity		TUV certification
	CSA mark for UL1973		UKCA mark of conformity
	The battery module may explode		Caution, risk of electric shock
	Caution, risk of danger		Safety glasses must be worn
	Read the enclosed documentations		Keep the battery system away from children
	Keep the battery system away from open flames or ignition systems		Do not dispose of the battery module together with household waste.
	Do not dispose of the battery module together with household waste.		
	The battery system must be disposed of at a proper facility for environmentally-safe recycling		

Note: The table is only used for the description of symbols which may be used on the battery. Please be subject to the actual symbols on the device.

 **DANGER!**

In the case of any of following circumstances, electric shock may occur:

- Disassemble the battery module;
- Touch the battery module with wet hands;
- Install or operate the battery module in places where there is excessive moisture or liquids.

 **WARNING!**

In the case of any of the following circumstances, personal injury or battery damage may occur:

- The battery module was involved in a collision;
- Crush or puncture the battery module;
- Dispose the battery module in a fire;
- Expose the battery module to the temperature in excess of 140 °F ;
- Place the battery module near a heat source, such as a fireplace;
- Expose the battery module to direct sunlight;
- Allow the battery connectors to touch conductive objects, such as wires;
- Place the battery module in a high-voltage environment;
- Place any objects on the top of the battery module.

 **CAUTION!**









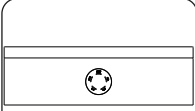

- Keep children away from the battery module;
- Please check the battery module periodically. Personal injuries may be caused if not handled properly.

NOTICE!

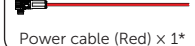
- In case the battery module leaks electrolyte or any other chemical materials, be sure to avoid contact with the discharge at all times. In case of accidentally coming into contact with them, always wash your hands thoroughly with soap and water afterwards. In case of eye contact, seek medical attention immediately.
- If a fire breaks out where the battery module is installed, extinguish the fire before the battery catches fire; in case the battery module catches fire, do not try to put out the fire, and evacuate immediately.
- In case the battery module gets wet or is soaked in water, do not touch.
- In case the battery module is damaged, do not use it. Otherwise, it may result in both personal injury and property damage.

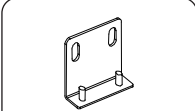
Packing List

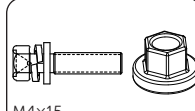
BMS (TBMS-MCS0800)

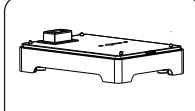
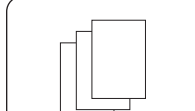
 <p>BMS x 1</p>	 <p>Communication cable x 1 (BMS port)</p>  <p>Short power cable x 1</p>	 <p>Power cable (Black) x 1*</p>  <p>Power cable (Red) x 1*</p>	 <p>Adjustable bracket x 1</p>
 <p>Adjustable L bracket x 1</p>	 <p>Rotation wrench x 1</p>	 <p>RNB5-6 Current terminal x 2</p>	 <p>M4x15 Phillips-head Screw x 2 M6 Flange nut x 2</p>
 <p>Tapping screw x 2 Washer x 2 Expansion bolt x 2</p>	 <p>M4x14 M4 Washer Phillips-head Screw x 4</p>	 <p>Pedestal x 1</p>	 <p>Document</p>

Note: The mark "" indicates that the connector connecting inverter on the power cable, connecting BMS and inverter, is delivered with the inverter's accessories kit.

Battery Module (TP-HS25/ TP-HS36)

 <p>Battery module x 1</p>	 <p>M4x14 M4 Washer Phillips-head Screw x 2</p>	 <p>Document</p>
--	--	---

Series Box

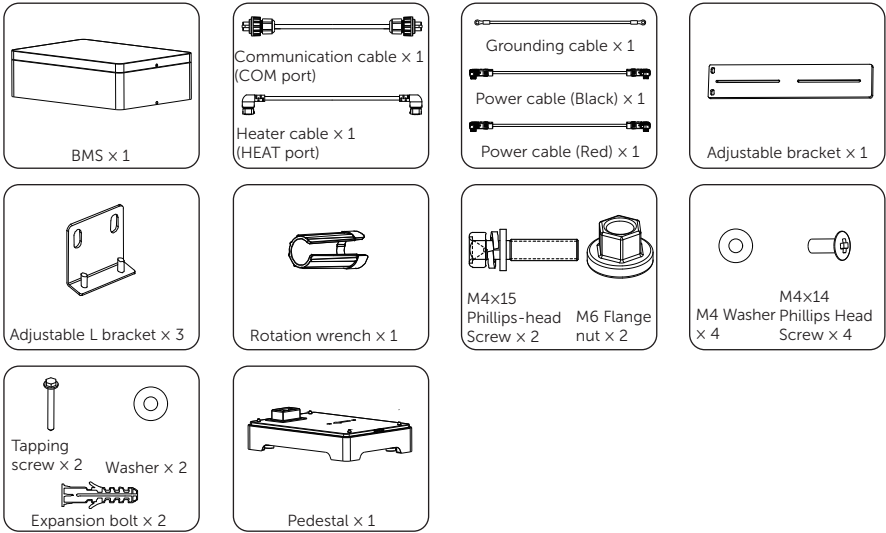

*Note:

1. If the battery module purchased exceeds 10 sets (including 10), these battery modules should be installed in two groups, and the Series Box should be installed to connect two groups in series.
2. If the battery module purchased is less than 9 sets (including 9), these battery modules may be installed in one or two groups. In case of two groups, the Series Box is recommended to install.
3. Additionally, the above accessories kit for Series Box needs to be purchased by customers themselves.

Installation Site

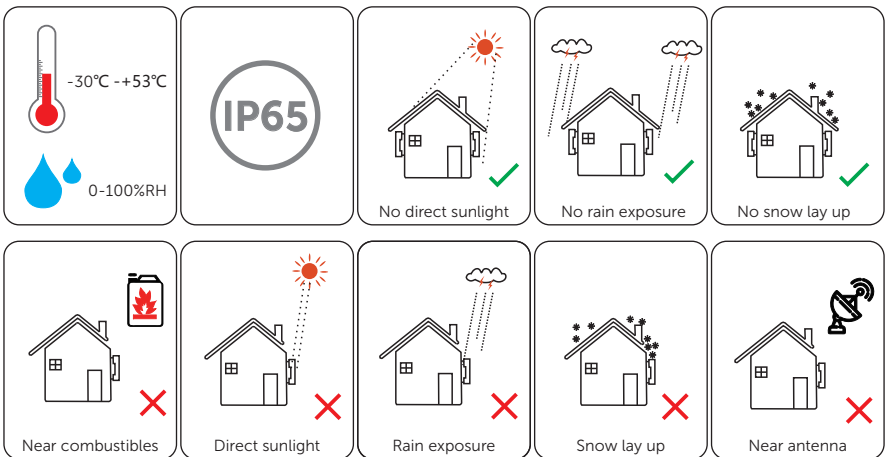

Installation Space

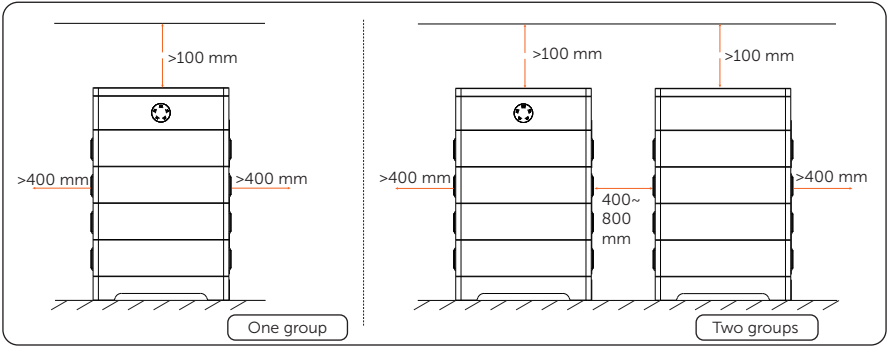

*Note: The above figure shows an example of installation space of "One Group" and "Two Groups".

Installation Tools

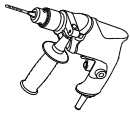

Drill

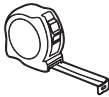

Measuring tape



Marker

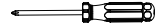

Cross screwdriver

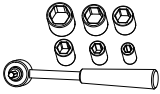

Torque wrench (M4)

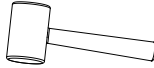

Mallet



Spirit level

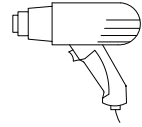

Hot-air blower



Wire stripper

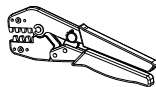

Crimping tool

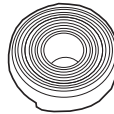

φ6 mm Heat shrink tubing

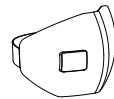

Anti-dust mask



Safety gloves



Safety boots



Safety goggles

Mechanical Installation

*Note: Up to 9 battery modules can be installed in a group. If the battery module users purchased exceeds 10 sets (including 10), a Series Box needs to be installed to connect two groups in series.

Installation steps without Series Box

Take the installation procedure for four battery modules as an example.

Step 1: Take out and adjust Pedestal

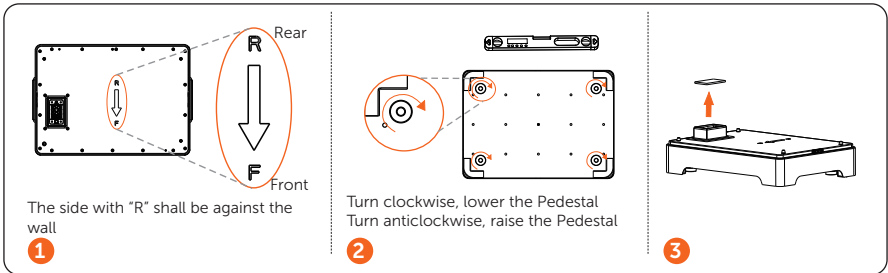

Step 2: Locate the Pedestal, and accurately draw the location on both sides

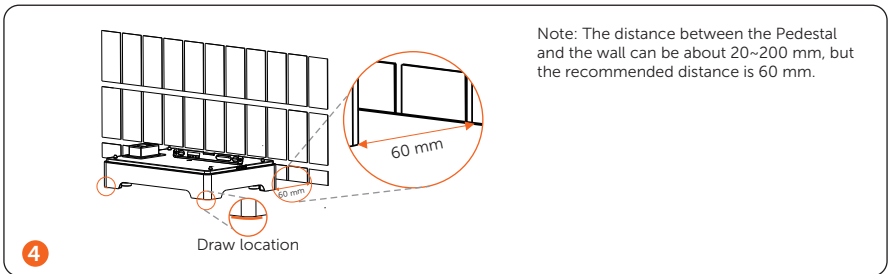

Step 3: Place the battery module

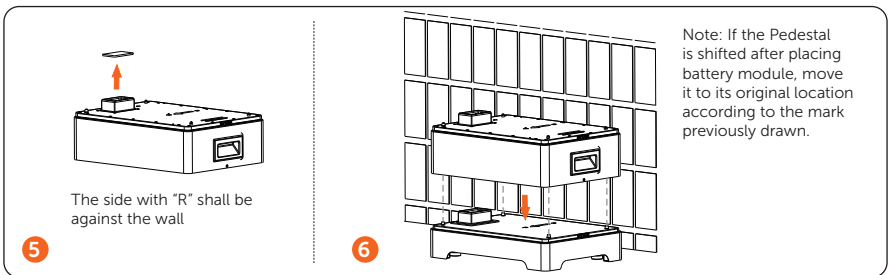

Step 4: Secure and tighten M4x14 Phillips-head screw on both sides

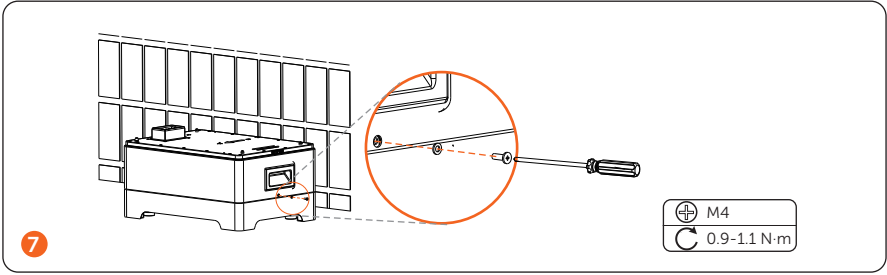

Step 5: Repeat the Step 3 and 4 to install the rest of battery modules

Step 6: Join Adjustable Bracket and Adjustable L Bracket with M6 Flange Nut

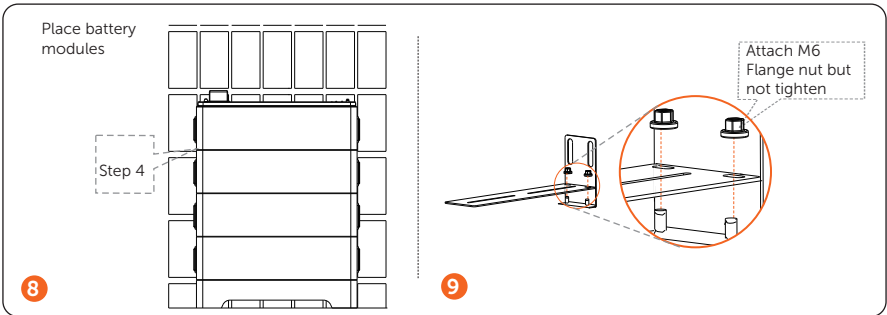

Step 7: Secure the assembled bracket on the battery module and wall

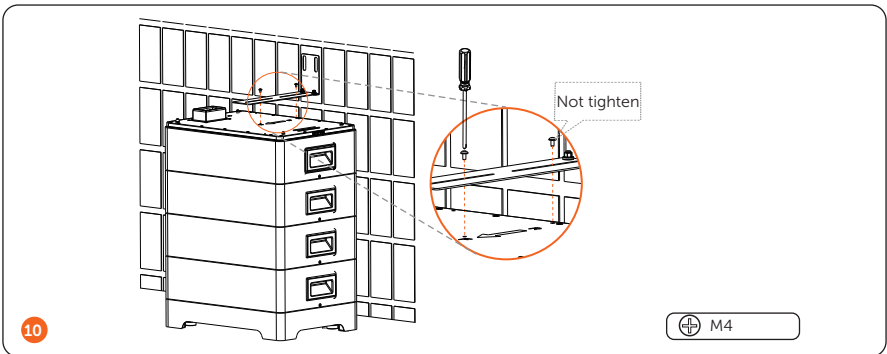

Do not remove dust cover
on the top battery

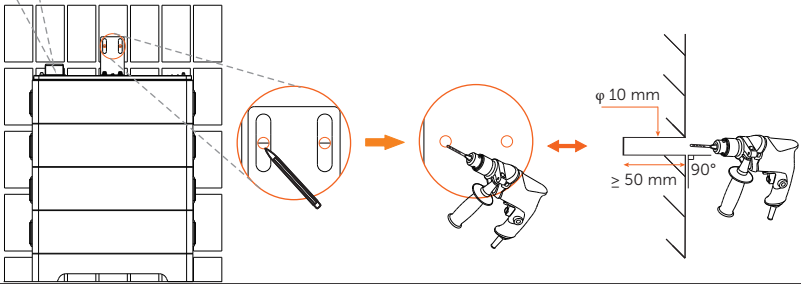

Remove
bracket

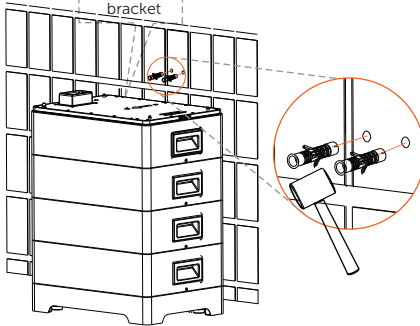

Remove
dust cover

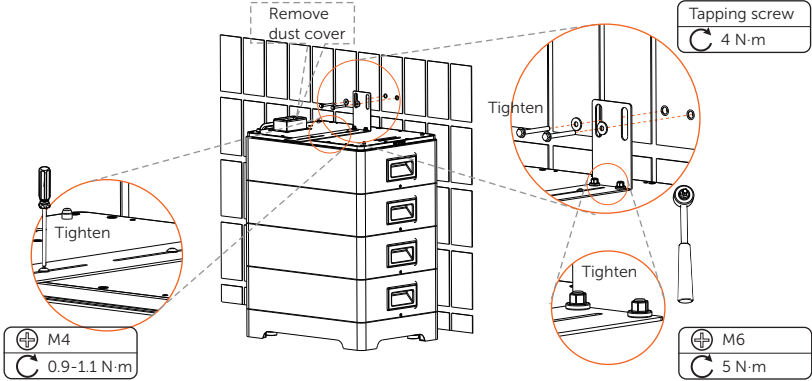

Step 8: Place BMS

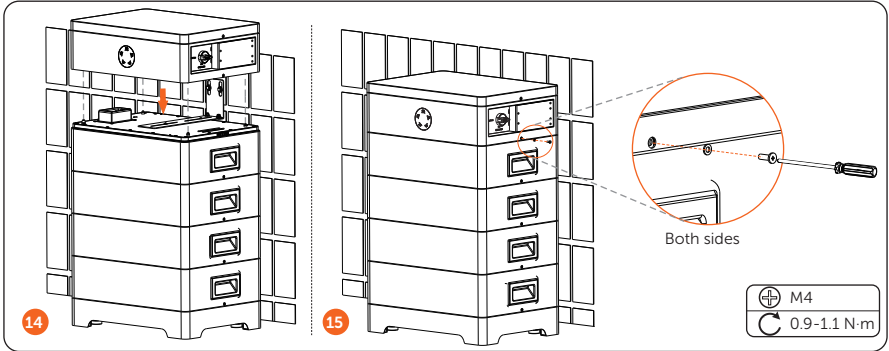

Installation steps with Series Box

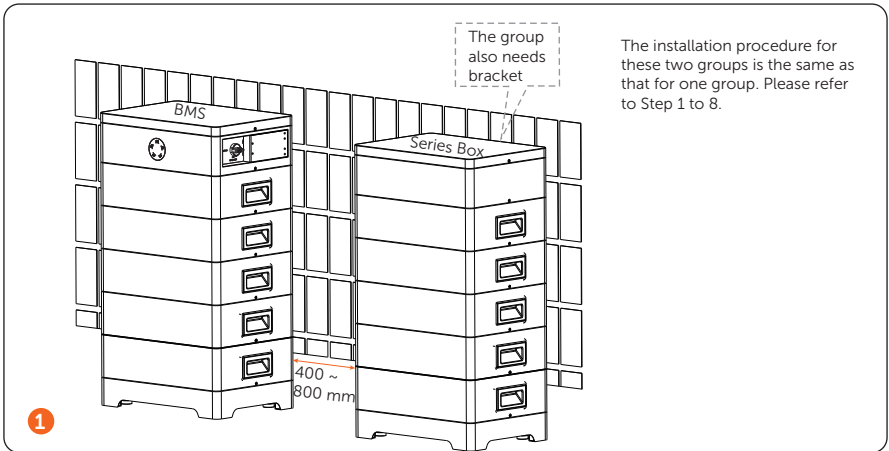

Current Terminal Connection

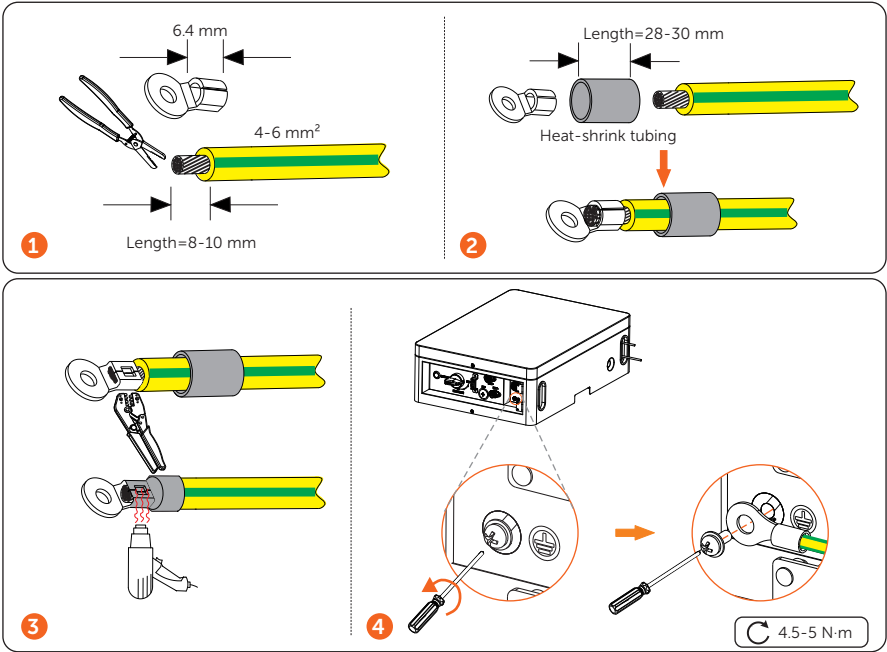

*Note: The grounding cable should be prepared by the users themselves.

Communication Connection (connecting to inverter)

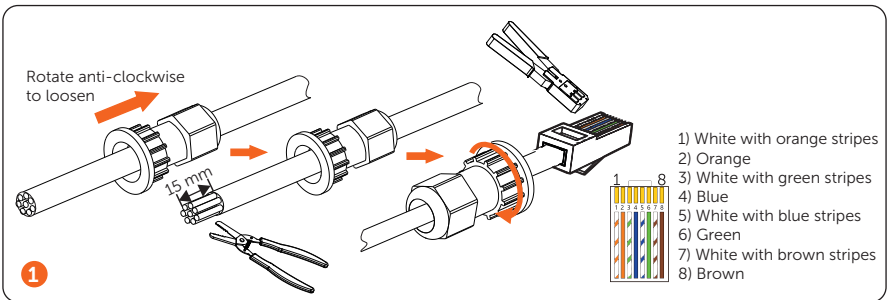

Pin	1	2	3	4	5	6	7	8
BMS	/	GND	/	BMS_H	BMS_L	/	A1	B1

Wiring

*Note: Press the door panel at both sides of BMS before wiring.

Wiring without Series Box

Left side of BMS

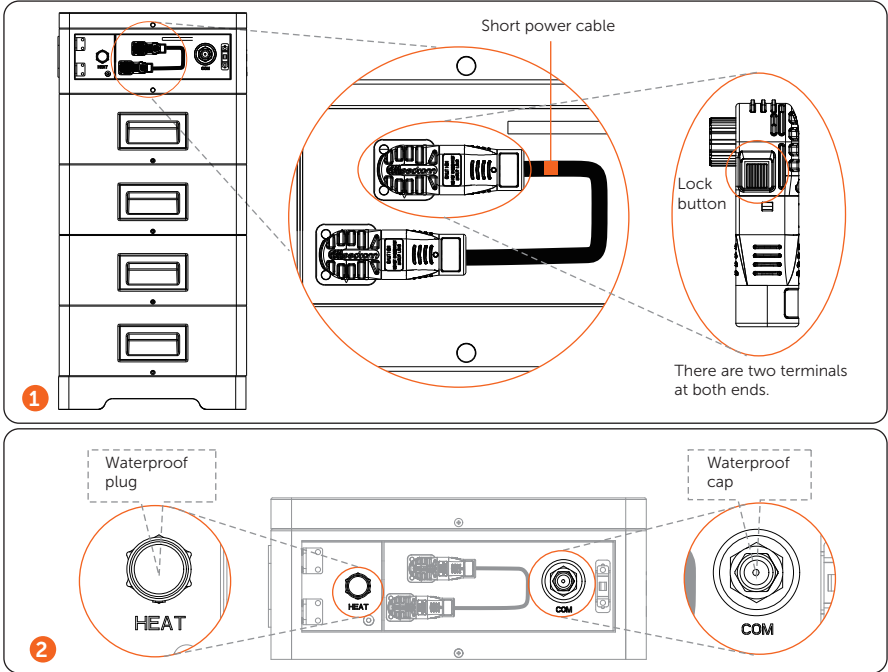

*Note: In case of one group, a waterproof cap shall be put on the unconnected COM port, as well as a waterproof plug on the unconnected HEAT port.

Right side of BMS

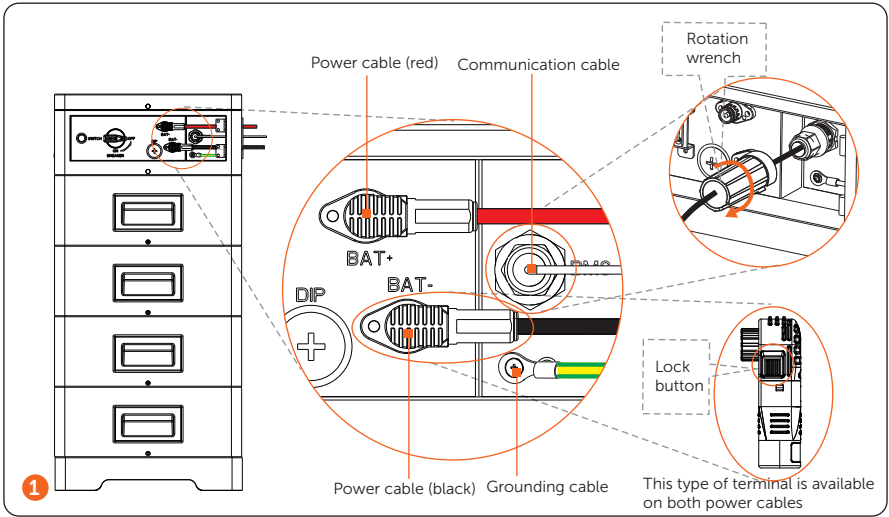

*Note:

1. Press and hold the Lock Button while unplugging the power cable, or it cannot be pulled out.
2. The rotation wrench is used to tighten the communication cable, and it may be removed after tightening.

Wiring with Series Box

Wiring between BMS and Series Box

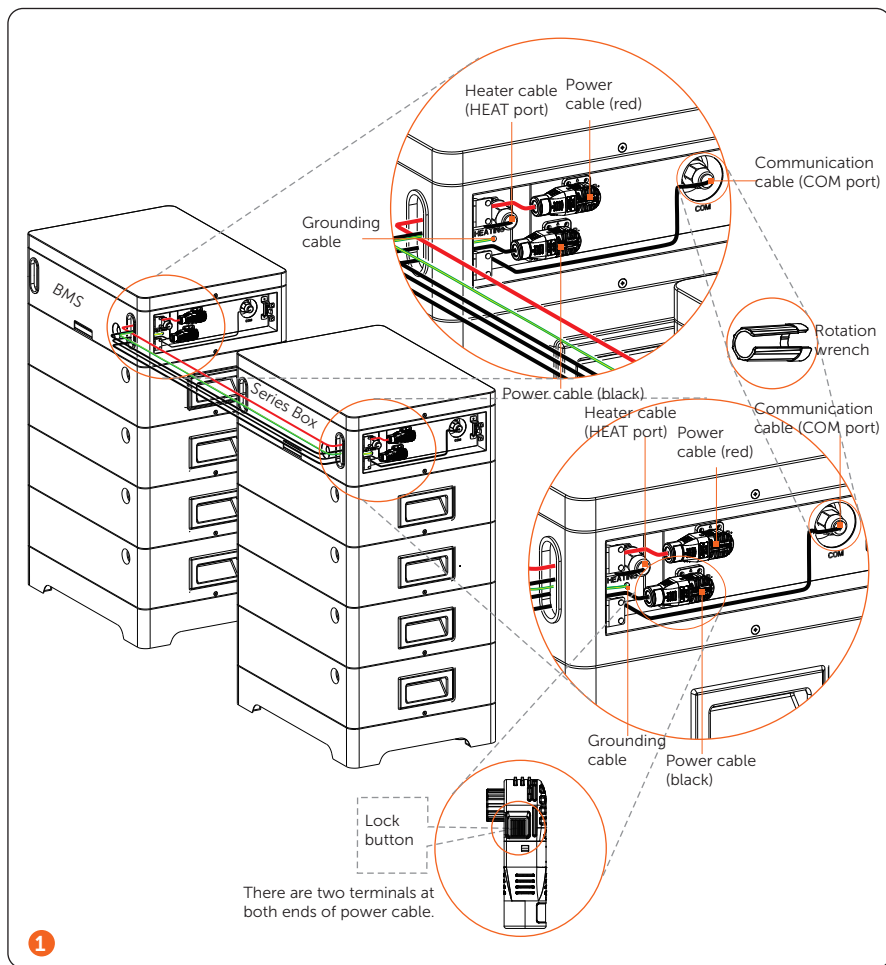

*Note: A protective pipe is recommended to use to keep cable insulation in place and avoid potential damages.

Make sure that the heater cable is locked

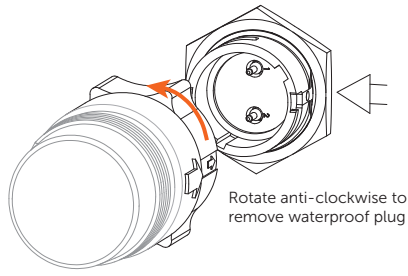

Rotate anti-clockwise to remove waterproof plug



Insert heater cable into HEAT port, and rotate clockwise to lock it

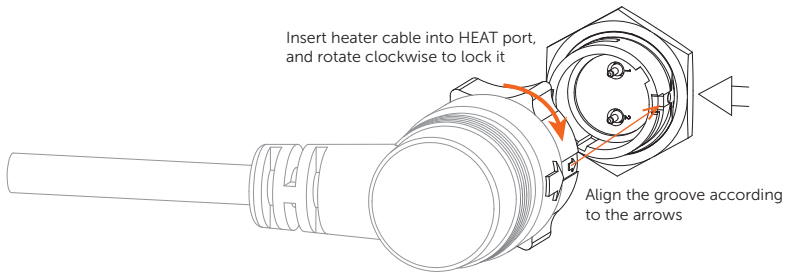

Align the groove according to the arrows

2

Right side of BMS

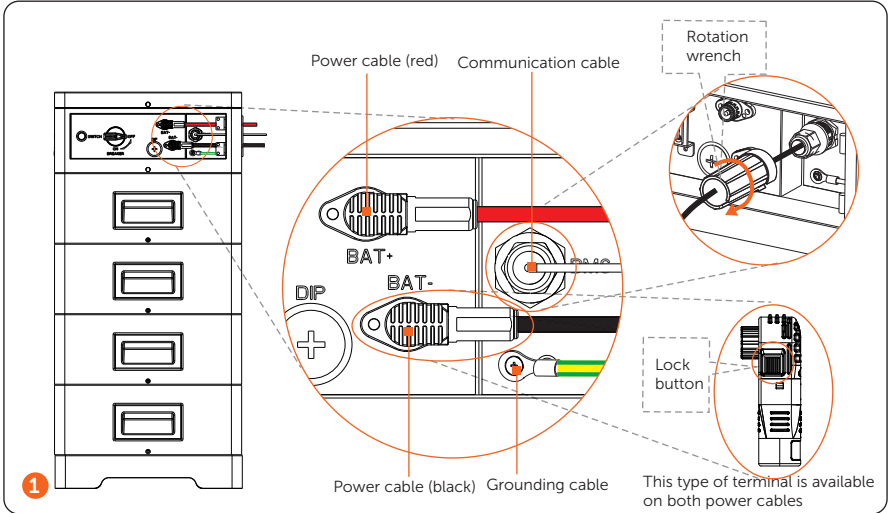

*Note:

1. Press and hold the Lock Button while unplugging the power cable, or it cannot be pulled out.
2. The rotation wrench is used to tighten the communication cable, and it may be removed after tightening.

Power on the System

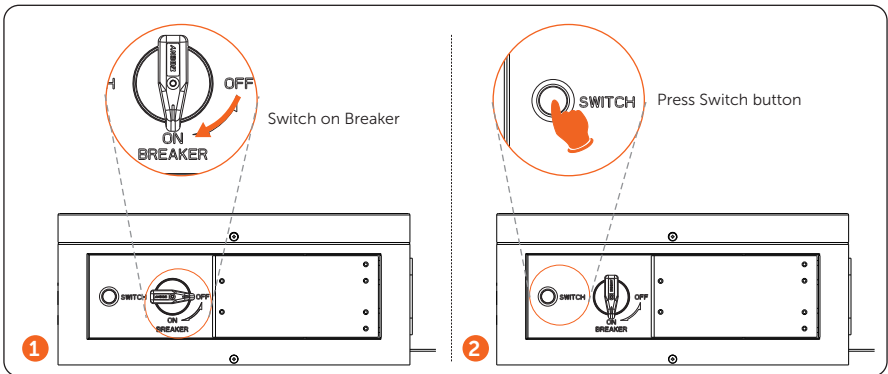

Contact Information



UNITED KINGDOM

- Unit 10, Eastboro Fields, Hemdale Business Park, Nuneaton, CV11 6GL
- +44 (0) 2476 586 998
- info@solaxuk.co.uk



TURKEY

- Esenşehir Mah. Hale Sk. No:6/1 Ümraniye / İSTANBUL
- +90 (216) 622 58 00 (pbx)
- service.eu@solaxpower.com



USA

- 3780 Kilroy Airport Way, Suite 200, Long Beach, CA, US 90806
- info@solaxpower.com



POLAND

- WARSAW AL. JANA P. II 27. POST
- +48662430292
- Thomas.W@solaxpower.com
- service.pl@solaxpower.com



ITALY

- +393518157758
- tecn.it@solaxpower.com



AUSTRALIA

- 12-18 Lascelles St, Springvale VIC 3171
- +61 1300 476 529
- support@solaxpower.com.au



GERMANY

- Eisenstraße 3, 65428 Rüsselsheim am Main, Germany
- +49 (0) 6142 4091 664
- service.eu@solaxpower.com



NETHERLANDS

- Tweekeler-Es 15 7547 ST Enschede
- +31 (0) 8527 37932
- service.eu@solaxpower.com
- service.bnl@solaxpower.com



SPAIN

- +34683197401
- tecnico@solaxpower.com



BRAZIL

- +55 (34) 9667 0319
- info@solaxpower.com

Warranty Registration Form



For Customer (Compulsory)

Name _____ Country _____
Phone Number _____ Email _____
Address _____
State _____ Zip Code _____
Product Serial Number _____
Date of Commissioning _____
Installation Company Name _____
Installer Name _____ Electrician License No. _____

For Installer

Module (If Any)

Module Brand _____
Module Size(W) _____
Number of String _____ Number of Panel Per String _____

Battery (If Any)

Battery Type _____
Brand _____
Number of Battery Attached _____
Date of Delivery _____ Signature _____

Please visit our warranty website: <https://www.solaxcloud.com/#/warranty> or use your mobile phone to scan the QR code to complete the online warranty registration.



For more detailed warranty terms, please visit SolaX official website: www.solaxpower.com to check it.





SolaX Power Network Technology (Zhejiang) Co., Ltd.

Add.: No. 288, Shizhu Road, Tonglu Economic Development Zone,
Tonglu City, Zhejiang Province, 310000 P. R. CHINA

Tel.: +86 (0) 571 5626 0011

E-mail: info@solaxpower.com / service@solaxpower.com

